











DRESS DESIGN & MAKING, FASHION DESIGNING

Sr#	Name of Item	Specification	Reference Picture	GTVC (W) Abtd	GTV C (W) H Pesh	GTVC (W) Mansehra	GTV C (W) Charsad da	GTVC (W) DIK	GTVC (W) G Psh	GTVC (W) Kohat	GTVC (W) Kark	GTVC (W) Totano Swat	Total No	Unit Price (Inclusive All Taxes & Transportation)	Total Price (Inclusive All Taxes & Transportation)
1.	Tri set square Wooden	12", 24" Hardwood Try Set Square and hardened steel blade.		25	0	25							50		
2.	Dressmaker's Wooden curve	Size: 24" Material: Wood		25	0	25							50		
3.	Scissors large	Size: 10" blade: hand polishing, hand color black, Material:- Stainless Steel Screw:- Adjustable		25	0	25		5					55		



4.	Scissors small	Zigzag- teeth width: 7mm, teeth height: 2.2 mm, teeth quantity 10 teeth, high quality stainless steel.		25	0	48							73		
5.	Ruler steel	Size: 12", Material: stainless steel,		50	0							50			
6.	Geometrical sets Engineering	Geometry Set contains a 20cm Rule, 180 degree Protractor, 45 degree set squares and 60 degree set squares.		50	0							50			
7.	Electric irons	Soleplate type: AL-Alloy volt:220-240 phase: single power: 750 Watt current: 3A Fuse: miniature time-delay.		0	1	10	5			1		17			

8.	Cloth Dying pots	33 and 50 liters Stainless dye pots		4	0								4		
9.	Water tubs	Size: 17, 19, 22 inch Plastic: Unbreakable plastic Capacity: 80 ltr		6	0								6		
11.	Single needle Lockstitch industrial sewing machine, Heavy duty	Speed: 8700-max 5500.Clearance under foot: 5.5 by hand- by knee13mm Needle bar stroke: 30.7mm stitch length -maximum 5mm Bobbin-metal hook143342Bed size: 7"×18 25/32"Automatic grade: ManualMax Sewing Speed: 2000-3000 stitch/min		5	0								5		

14.	Industrial Button hole machine, Heavy duty	<p>Type of sewing material light, medium</p> <p>Type of buttonhole machine mechanical</p> <p>Buttonhole type lockstitch buttonhole</p> <p>Buttonhole width 2.5 - 5.0 mm</p> <p>Buttonhole length 6.4 - 25.4 mm</p> <p>Length of the cutting knife 6.4 - 19.5 mm</p> <p>Max. sewing speed 3600 s.p.m.</p> <p>Needle system 135x5</p> <p>Lubricating fully – rotary type</p>		0	0						1	2	3		
15.	Measuring tapes	<p>CLASSIC</p> <p>YELLOW SEWING</p> <p>TAILOR 3</p> <p>METERS</p> <p>MEASURE</p> <p>FABRIC</p> <p>MEASURING</p> <p>TAPE RULER</p>		25	0	72						25	97		

16.	Tracing wheel	Pitch:2mm Length:160mm Width:80mm Leather Craft Fabric Serrate Tracing Wheel Sewing Tool With Wood Handle		25	0								25		
17.	Crochet, lace and loops machines	Lacing speed: About 0.7s per slot Lacing method: Slot by slot / interval slot / fancy lacing Suitable stator stacking height: 10~100mm		30	0	1							31		
18.	Dress forms (dummies), Ladies, Gents and Babies	Ladies shape: height 27 inches Width of 14 inches, a 34-inch bust, a 26-inch waist and 35-inch hips. Baby shape: 8-section body for maximum adjustment for growing children 10 quick set adjustments to set your size 3 leg base for stability Gents shape:		6 each	0			5			5	5			

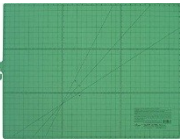

		<p>Chest: 37" to 45" (94-114cm) Waist: 32" to 40" (82-101cm) Hips: 39" to 47" (99-119cm) Back Length: 16" to 18½" (41-47cm)</p>															
19.	Wooden soft Drawing boards (24×36")	<p>wood with metal edge, vinyl edged, and white Melamine drawing board (24×36") complete with chrome plated stand</p>		25	0												
20.	Computerized flat knitting machine	<p>Average weight: 660 lbs Power: single phase AC 220 V Knitting width: max 45" Knitting speed: 1.2 m/sec Stich density: 120 levels Setup device: special setup needles Knitting followings: Collars, Full Cardigan, Rib, Taps, Half Sleeves, Full Sleeves, Bandkhol, Strips (Dora), School Uniforms, Muffler, RivertSceeve,</p>		0	0	1		1					20			20	45



		Pullovers, Sweat Shirts, Fabric etc. Model: SM-100 Gauge: 7 gg, 8 gg, 10 gg, 11 gg, 12 gg, 14 gg Bed Width: 28													
25.	Cutting Mat	24 inch x 36 inch Inch Gauge		25	0										
30.	Needle Grabber	2 rubber needle grabbers. Helps to grab the needles easily while guiding through tough or thick materials.		50	0										
31.	Leather thimbles	Material leather or silver, With metal tip for Sewing Needle Quilting		30	0										
													25	30	



25



5 50



25 30



33.	Iron	Soleplate type: AL-Alloy volt:220-240 phase: single power: 750 Watt current: 3A Fuse: miniature time-delay.		3	1								5	3	9
34.	Iron shoe	Teflon Sole Plate Iron Shoe Dimension: 21.5cm x 12.5cm x 11cm		6	1								5	3	12
35.	Fabric steamer	1200W Handheld Garment Steamer, Portable Home and Travel Steamers for Clothes with 260ml Removable Water Tank Vertically & Horizontally Steam		0	1								5	1	6



36.	Steam Iron	Steam 35g/min;120g steam boostSafety Auto off + Anti- calcSoleplate: Ceramic soleplateSteam output: YesContinuous steam output: 35 g/minSteam boost: 120 gVertical steaming: YesSpray: YesPower: 2300 WWater tank capacity: 270 mlDrip stop: YesSafety auto off: YesReaching tricky areas: Triple precision tip		0	1	5									
37.	Steam press	Pressing Plate Size 20"W x8"D Water Capacity 5.07 oz. Heating Time 3 min Fabric Settings 5 Item Dimensions 20.5"W x 17.2"D x 6.7"H Watts 1500 Volts 220 Power Cord Length / Type 6.6 ft. / 3-Pin Grounded		0	1			2				1	8		
								3			1		5		

38.	Stitch Full-size Sewing Machine	17 unique built-in stitches, including one 4-step auto-size buttonhole 4 included sewing feet: zigzag foot, zipper foot, buttonhole foot, button sewing foot Brightly lit LED-lit work area Free arm for sewing cuffs and sleeves Included instructional CD		0	1	1	1	5				1	8		
39.	Heavy Duty Model Sewing Machine	With 23 Built-In Stitches Fully Automatic 1-step Buttonhole 4 Stretch Stitches 12 Decorative Stitches 6 Basic Stitches Length: 135x17		0	1			2				0	3		

40.	Cover stitch sewing machine	cylinder bed sewing machine Application Light to medium heavy material Max. sewing speed 5000 rom Max. stitch length 4.4 mm Lift of the pressor foot 5.5 mm Needle type UY128GAS 9-14# Measurement 0.146 cbm		0	1							2	1	3	
41.	Fashion maker sewing machine	8 Built In Stitches Including- Straight, Zig-zag, Blind Hem and More! 4 Snap-on Presser Feet Heavy Duty Metal Frame Built-in Motor Adjustable Stitch Length and ZigZag Width Free Arm with Accessory Storage Automatic Bobbin Winding Quick and Easy Threading Automatic 4-Step		0	1		5	5					1	11	

43.	Simple sewing machine with handle	Fine quality Body Shape :Round Machine Color :Black Motion of Thread Take Up Lever: Cam Motion Needle Bar Thread Guide : Curved type Needle Plate and Slide Plate: Slide Type Presser Foot :Medium Shank Pressure Adjustment :Screw Type		0	1	50	10	5	25	10	15	20	136	
44.	Sewing machine motors	Single phase Speed: high speed Excitation mode: HB hybrid No. of poles: 2		30	1	50	5	25	10	15	20	156		
45.	Zigzag sewing machines	ZigZag& Straight Stitch Machine Simple Stitch Length & ZigZag Width Adjustment Reverse Feed Includes 550W		0	1	25	10				1	36		

		Adjustable Speed Servo Motor Stitch width 12mm													
46.	Embroidery machine	Large 5" X 7" Embroidery Field 184 Built-In Sewing Stitches Backlit LCD Touch Screen My Custom Stitch Feature Automatic Needle Threader		5	1			10							
47.	Zigzag scissor	Zigzag- teeth width: 7mm, teeth height: 2.2 mm, teeth quantity 10 teeth, high quality stainless steel.		0	1			10			2		28		
48.	Drafting tables	Main Work Surface: 36"W x 24"D. Overall Dimensions: 36"W x 24"D x 34.25"H (when flat). Adjustable Angle Table Top from Flat to 80 Degrees. Built-in Pencil Groove with 24"		10	1		5	5				0	16		

52.	Drawing table	with metal foots chrome plated , wooden top 24”X 36” Adjustable		5	0					10		5	15		
53.	0	0		0	0								0		
54.	Library show cases	3 × 1.5 × 6ft with glass and 4 shelves 20-22 gage steel sheets		6	0		2					1	8		
61.	Sewing machine table	Industrial Sewing Machine Table, Stand White Wood Edged Material: wood Dimensions: 120x55mm		30	1	50			5	25	10	15	20	156	

		MotifSize: 1.4m long												
9.	ZIG ZAG SEWING MACHINE	<ul style="list-style-type: none"> ● 8 Built-in Stitches ● The right stitch: easier sewing with better results Includes: <ul style="list-style-type: none"> ● 6 Essential, 1 Decorative ● Automatic 1-Step Buttonhole. 		0	0	5							5	
11.	OVERLOCK MACHINE	Stich type: 3-needle safety stitching Max. sewing speed: 7,000sti/min Stitch length: 0.6~3.8mm Needle gauge(mm): 5.0+2.0 Overedging width(mm): 3.0		0	0	2								
							1		1	2			6	
19.	SCISSORS	Length: 10.5-inch or 26.7cm Blade thickness: 3.0mm Hardness: 40 to 48° Surface treatment: sand polishing		0	0	48								48
	Iron Table			1	1	2							4	

	ADA Large 6ft x 4ft					3							3			
	ADA small 4ft x 4ft					5							5			
	Frame Large 12"					60							60			
	brush (Siblon)					36							36			
	Frame small 8"					60							60			
	trace box 4 x 4ft					4							4			
	Fabric printing brushes (0 to 10)					3							3			
	knitting needle No 13					48							48			
	crochet yarn					48							48			
	crochet wool					48							48			
	Pico Machine (Interlock) 747 oxford						1+A 3:11 05				1	1	1	2		
	Fabric Printing Block Different size							50			1		1	51		
	Kaj Machine juki 781 china										2	2	1	4		

	Paff Goda Machine singer puff 130										2			2		
--	--	--	--	--	--	--	--	--	--	--	---	--	--	---	--	--